

GENETIC GENEALOGY: WHAT LIBRARIANS NEED TO KNOW ABOUT DNA TESTING

Rosemary Meszaros

Government Documents & Law



Katherine Pennavaria

Visual & Performing Arts Library



WKU Libraries
June 9, 2015

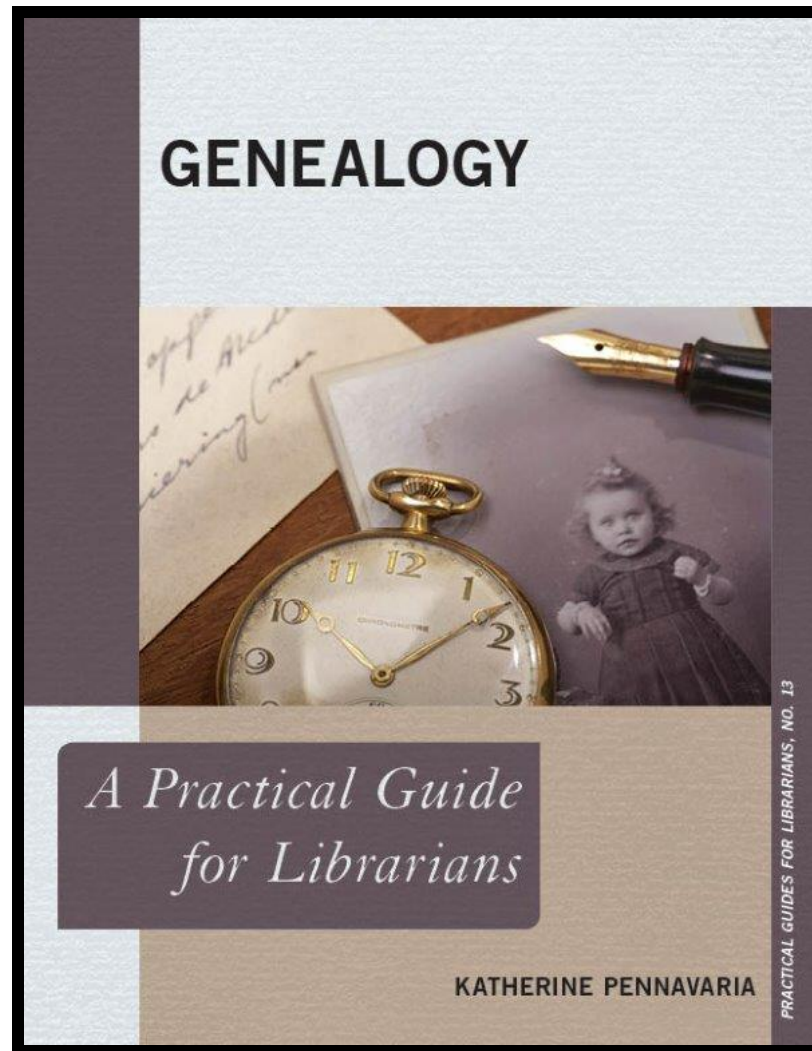

GENEALOGY: A PRACTICAL GUIDE FOR LIBRARIANS

Katherine Pennavaria

Rowman & Littlefield

March 2015



Henrietta Lacks

“HeLa” cell line

One tissue sample → **immortality** (sort of)

DNA IS HERE TO STAY



MEDICAL RESEARCH



PATERNITY QUESTIONS



CRIME SCENES



GENEALOGY

FIND OUT:

1. **your ethnicity**
2. **your relatives in the database**
3. **your haplogroup**
4. **your percentage of Neanderthal DNA**

FACTS



DNA Test Report For Personal Knowledge Only

DDC8888810008
88800

DDC is accredited/certified by AABB, CAP, ACLASS for ISO/IEC 17025, CLIA, NYSDOH & ASCLD/LAB-International.

Case: 456789 Name	MOTHER Jane	CHILD Jenny	Alleged FATHER John
Date Collected: Test No.	1/1/2010 456789-10	1/1/2010 456789-20	1/1/2010 456789-30
Locus	PI	Allele Sizes	Allele Sizes
D8S1179	1.55	10 14	11 13
D21S11	2.02	27 29	29 30
D7S820	1.17	8 10	10 11
CSF1PO	1.65	11 12	11 12
D3S1358	1.88	14 17	14 15
TH01	2.62	6 9.3	7 9
D13S317	3.43	13	11 13
D16S539	3.32	9 12	11
D2S1338	4.33	19 20	23 24
D19S433	2.23	13	13 14
vWA	3.62	14	14 17
TPOX	1.86	11	8 11
D18S51	3.06	15 17	13 14
D5S818	1.35	12 13	11 12
FGA	3.55	21 22	21 24
Amelogenin	X	X	X Y
Interpretation:	Combined Paternity Index: 323,769		Probability of Paternity: 99.9996%
The alleged father is not excluded as the biological father of the tested child. Based on testing results obtained from analyses of the DNA loci listed, the probability of paternity is 99.9996%. This probability of paternity is calculated by comparing to an untested, unrelated, random individual of the Caucasian population (assumes prior probability equals 0.50).			

This DNA test was performed using the DDC DualProcess™ utilizing the AmpFISTR® Identifier PCR Amplification and an ABI 3730 DNA analyzer. DDC PlatinumPlex™ used as applicable.

Note: Since the samples were not collected under a strict chain of custody by a neutral party and the Laboratory cannot verify the origin of the samples, this test result may not be defensible in a court of law for the establishment of paternity and other legally related issues. The tested parties' names that may appear on this report have been provided by the client and cannot be verified. The laboratory assumes no responsibility for incorrect or misspelled client information.

Based on the samples received from tested parties whose identities cannot be independently verified, I, the undersigned Laboratory Director, declare that the genetic data is correct as reported on 1/19/2010.

Signature

Michael L. Baird, Ph.D.
Keen A. Wilson, Ph.D.
L. Farris Hanna, Ph.D.

Thomas M. Reid, Ph.D.
Pierig Lepont, Ph.D.
Marco Scarpetta, Ph.D.

DNA sequencing is a
complicated
science.

The raw results
require
interpretation.

ATGACCAACAAGTGTCTCCTCCAAATTGCTCTCCTGTTGTGCTTCTCCACTACAG
CTCTTTCCATGAGCTACAACCTTGCTTGGATTCTACAAAGAAGCAGCAATTTTCA
GTGTCAGAAGCTCCTGTGGCAATTGAATGGGAGGCTTGAATACTGCCTCAAGCAC
AGGATGAACTTTGACATCCCTGAGGAGATTAAGCAGCTGCAGCAGTTCCAGAAGG
AGGACGCCGCATTGACCATCTATGAGATGCTCCAGAACATCTTTGCTATTTTCAG
ACAAGATTCATCTAGCACTGGCTGGAATGAGACTATTGTTGAGAACCTCCTGGCT
AATGTCTATCATCAGATAAACCATCTGAAGACAGTCCTGGAAGAAAAACTGGAGA
AAGAAGATTTACCAGGGGAAAACCTCATGAGCAGTCTGCACCTGAAAAGATATTA
TGGGAGGATTCTGCATTACCTGAAGGCCAAGGAGTACAGTCACTGTGCCTGGACC
ATAGTCAGAGTGGAAATCCTAAGGAACTTTTACTTCATTAACAGACTTACAGGTT
ACCTCCGAAAC, and

ATGAGCTACAACCTTGCTTGGATTCTACAAAGAAGCAGCAATTTTCAGTGTCAGA
AGCTCCTGTGGCAATTGAATGGGAGGCTTGAATACTGCCTCAAGCACAGGATGAA
CTTTGACATCCCTGAGGAGATTAAGCAGCTGCAGCAGTTCCAGAAGGAGGACGCC
GCATTGACCATCTATGAGATGCTCCAGAACATCTTTGCTATTTTCAGACAAGATT
CATCTAGCACTGGCTGGAATGAGACTATTGTTGAGAACCTCCTGGCTAATGTCTA
TCATCAGATAAACCATCTGAAGACAGTCCTGGAAGAAAAACTGGAGAAAGAAGAT
TTCACCAGGGGAAAACCTCATGAGCAGTCTGCACCTGAAAAGATATTATGGGAGGA
TTCTGCATTACCTGAAGGCCAAGGAGTACAGTCACTGTGCCTGGACCATAGTCAG
AGTGGAAATCCTAAGGAACTTTTACTTCATTAACAGACTTACAGGTTACCTCCGA
AAC.

FACTS



**It cannot
be used to
recreate
scary
dinosaurs.
(so far)**

**WHAT DNA
SEQUENCING
HAS GIVEN US**



**BAD
GUYS
CAUGHT**

WWW.ADAMZYGCK.COM
THE BUFFALO NEWS
10/28 © 2007
ADAM ZYGCKS



SKELETON KEY

INNOCENT PRISONERS RELEASED

Chance

THIS CARD MAY BE KEPT
UNTIL NEEDED OR SOLD

GET OUT OF JAIL
FREE



HOPE FOR A CURE

Cancer Genomics

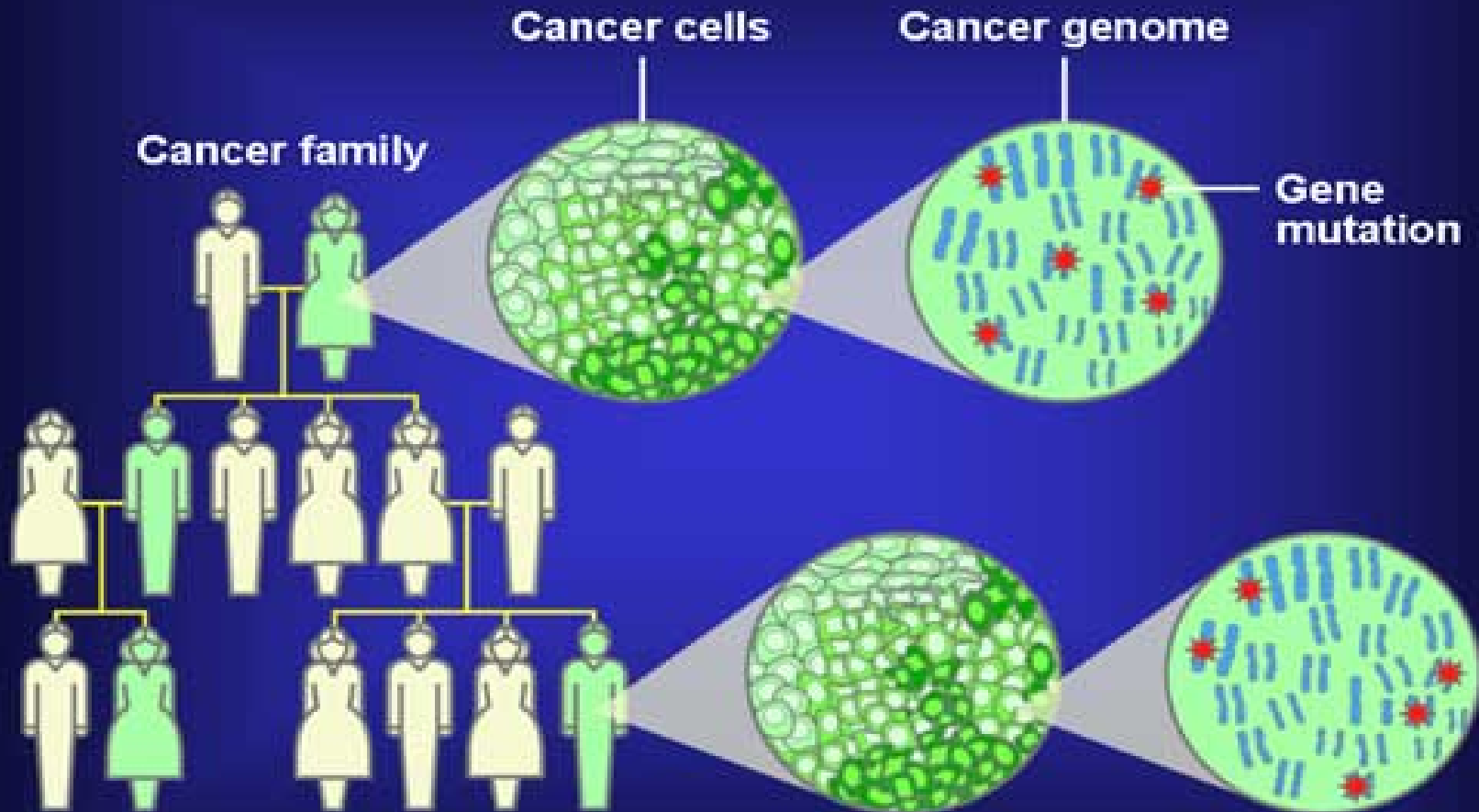

Illustration by American Society of Human Genetics

ADVERTISING

Family Tree DNA - Genetic Testing for Ancestry, Family ...

<https://www.familytreedna.com/> ▾ Family Tree DNA ▾

Establishing **DNA** fingerprints for the purpose of determining ancestral pedigrees.

Testing is available to both amateur and professional **genealogists**.

Login - Y-DNA - Family Finder - DNA Tests

List of DNA testing companies - ISOGG Wiki

www.isogg.org/wiki/List_of_DNA_testing_companies ▾

May 15, 2014 - This is a list of **DNA testing** companies offering **DNA tests** for **genealogy**, deep ancestry and ethnicity. This list is provided for information only.

Ancestry DNA Tests for Genealogists - Information

genealogy.about.com ▸ ... ▸ Genealogy ▸ Genetics, DNA & Health History ▾

Easy to understand guide to **DNA** and **genealogy** includes an introduction to the differences between Y-line and mtDNA testing, a guide to home **DNA** genetics ...

23andMe - Genetic kit for ancestry | DNA Service

<https://www.23andme.com/> ▾ 23andMe ▾

23andMe is a saliva-based DNA service. ... Contact your DNA relatives across continents or across the street; Build your **family tree** ... 99. 23andMe **DNA Test Kit** ...

How to Use DNA Testing for Genealogy Research - People

people.howstuffworks.com/.../genealogy/use-dna-testing-genealogy-rese... ▾

Using **DNA** for **genealogy** research is becoming more commonplace. Visit

Discover Your Ancestry with **DNA**.
Find Ethnic and Geographic Origins.

Genographic Project Kit

www.nationalgeographic.com/ ▾

Take the Revolutionary **DNA Test** By
Nat Geo & Discover Your Ancestry!

Free DNA Testing Kit

www.dnatesting.net/Free-DNA-Testing-Kit ▾

(866) 633-9127

Fast, Accurate **DNA Testing Results**.

Free, No-Obligation **Test Kit** Today.

\$79 for Complete DNA Test

www.dnafamilycheck.com/ ▾

Private and Legal **Testing Options**.

Results in 3 to 5 days.

Best DNA Ancestry Test

www.about.com/Best+DNA+Ancestry+Test ▾

Search for Best **DNA Ancestry Test**.

Find Expert Advice on About.com.

Free DNA Test Ancestry

Additional \$129 Laboratory Fee Required

Test Assured™

IDENTIGENE®



DNA PATERNITY TEST

COLLECTION KIT

For Alleged Father, Mother and Child

*Additional
\$129
Laboratory Fee
Required*

Results Typically Reported in 3 Days

1-888-404-GENE • www.IDENTIGENE.com



The leader in DNA testing for family history.

Family history is in our DNA. *What's in yours?*

Get personalized details about your ethnic origins.
Discover more about your story with advanced DNA
science from the experts in family history.

Now \$99

Get AncestryDNA



CONCERNS

I'VE DONE IT!!! I'VE CRACKED
THE HUMAN GENETIC CODE!!!
OOPS!!!

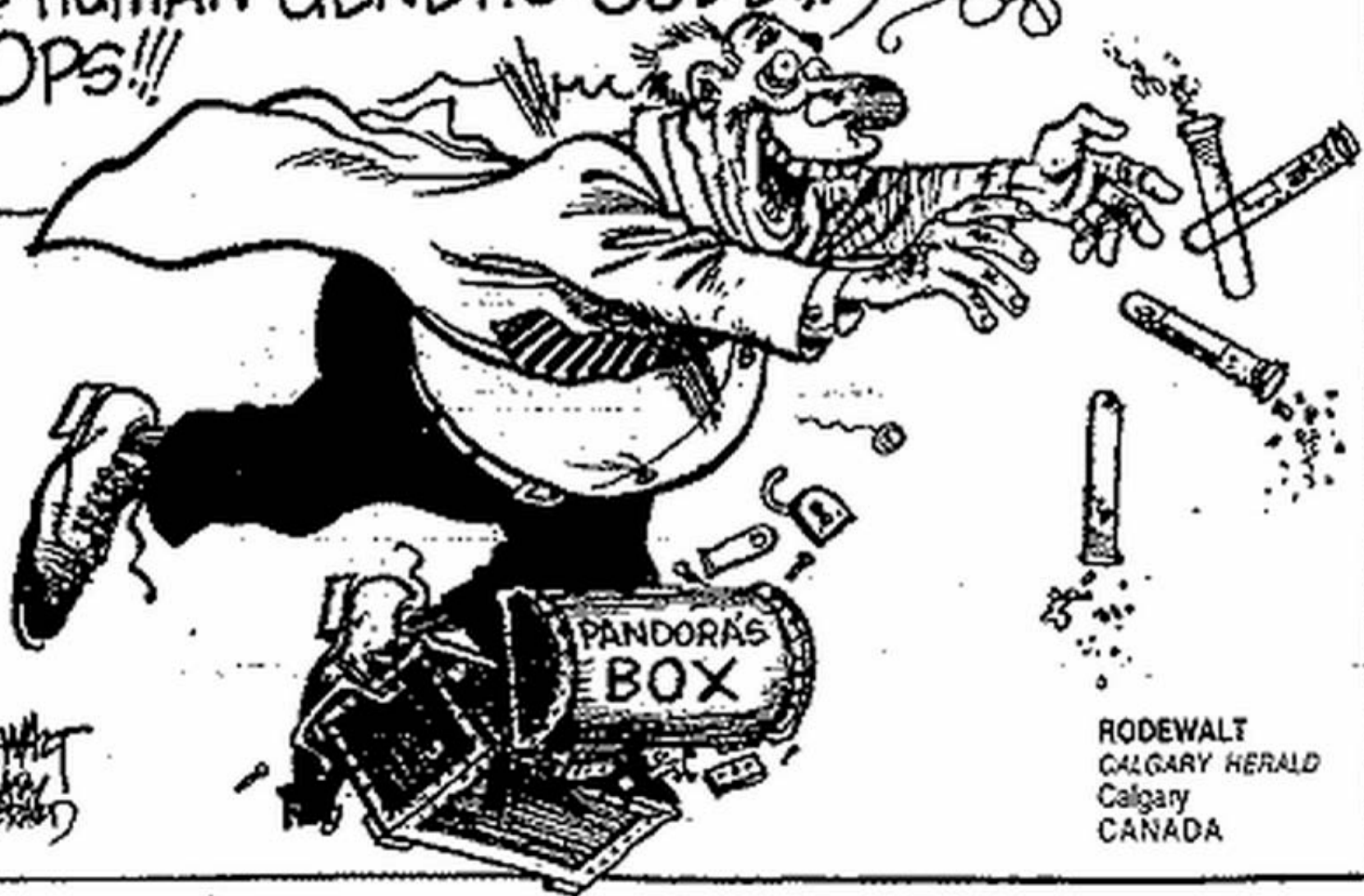

RODEWALT
CALGARY HERALD
CANADA

RODEWALT
CALGARY HERALD
Calgary
CANADA



**“I’m afraid we found annoying
personality markers in your DNA.
I can’t hire you.”**

IS PRIVACY COMPROMISED?

YES & NO

- ✓ **WHERE IS DNA DATA STORED?**
- ✓ **RESTRICTIONS FOR USE?**
- ✓ **DO WE CONTROL USE OF STORED DATA?**

FUZZY DATA

FBI: CODIS (COMBINED DNA INDEX SYSTEM)

STATE: NUMEROUS METHODS OF **STORING OR DESTROYING** DATA

HOSPITAL: NEWBORN DNA SAMPLES TAKEN **WITHOUT** PARENTAL CONSENT (**NBS**)

NIH: REMOVED THEIR DNA DATA FROM PUBLIC ACCESS ON WEB

KINSHIP SEARCHING

JOYS & SORROWS OF KINFOLK:

- MULTIPLE **COUSINS** OF WHATEVER DEGREE
- FIND FAMILY & CONNECTEDNESS
- FAMILY TREE “BRANCHES”

But: be careful what you wish for...



WHO REALLY OWNS YOUR DNA?

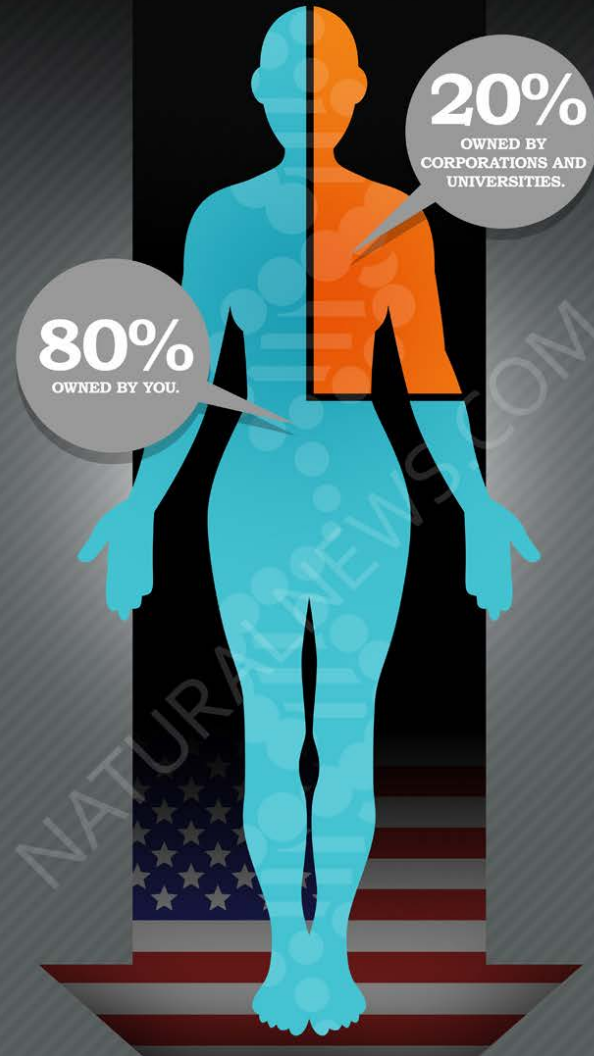

THREE TESTS ON ONE SAMPLE

DNA =

deoxyribonucleic acid

ONE SAMPLE

Y-DNA

mtDNA

atDNA

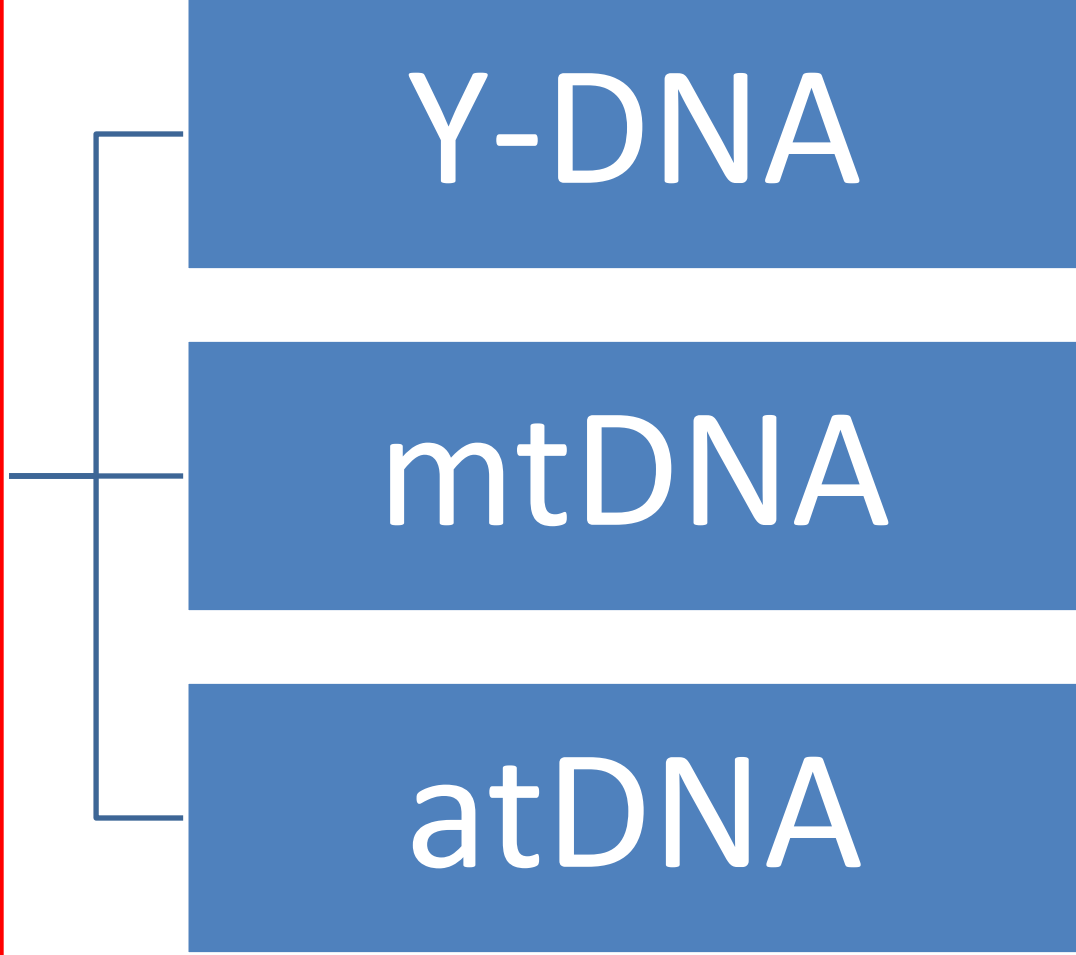

Y chromosome (*Y-DNA*)

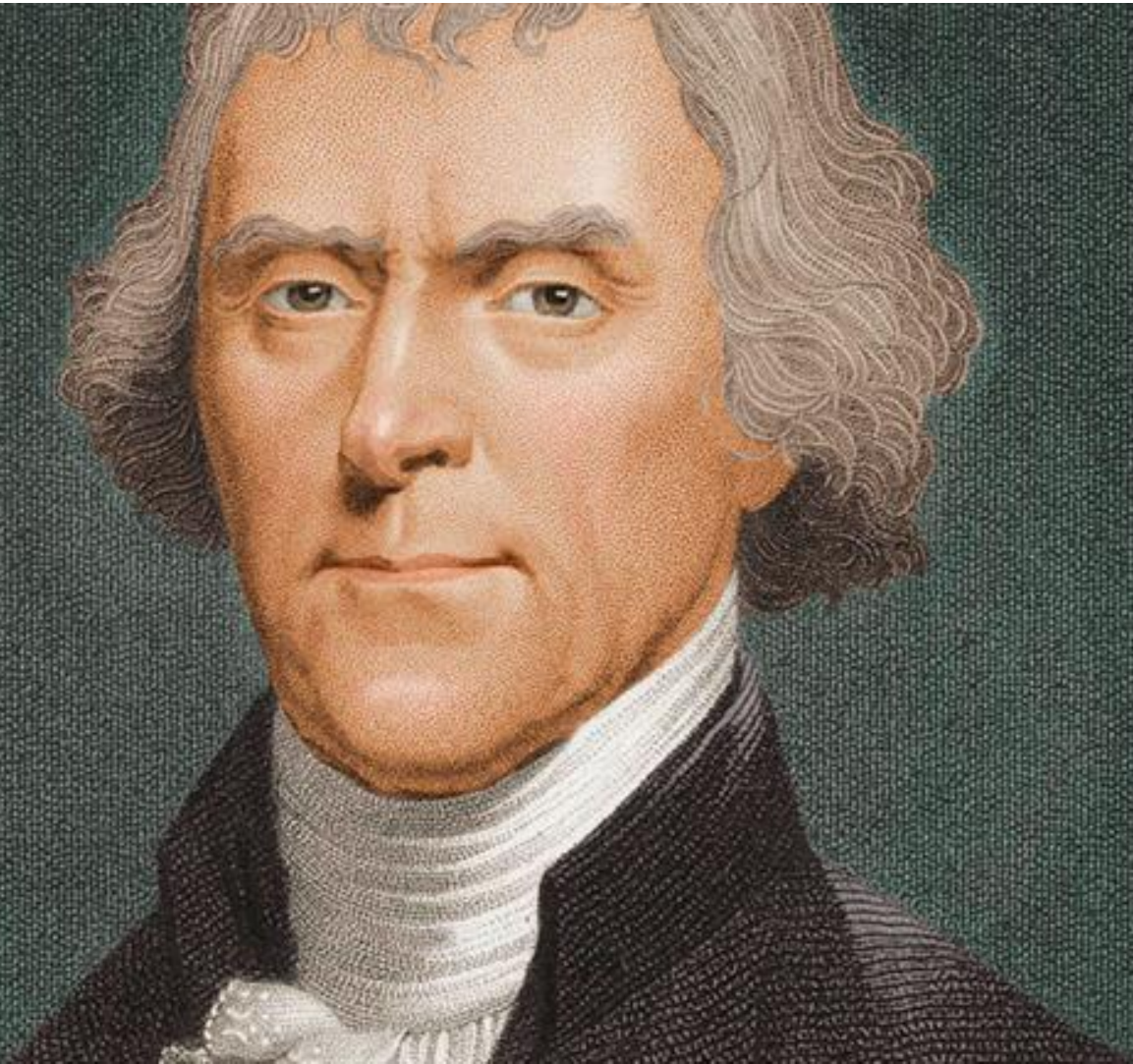

Mitochondrial DNA (*mtDNA*)



TRACKING THE **PATERNAL** AND **MATERNAL** LINES

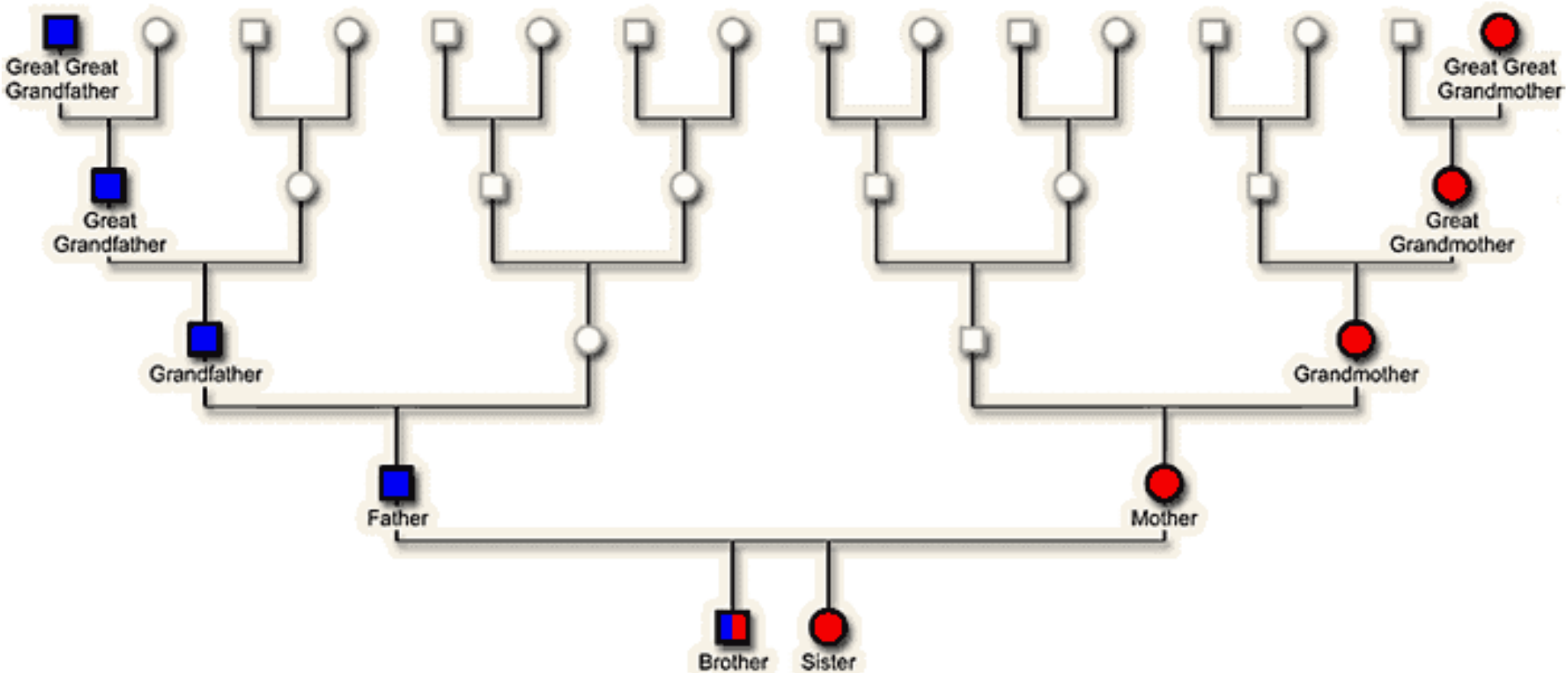

Pedigree Chart

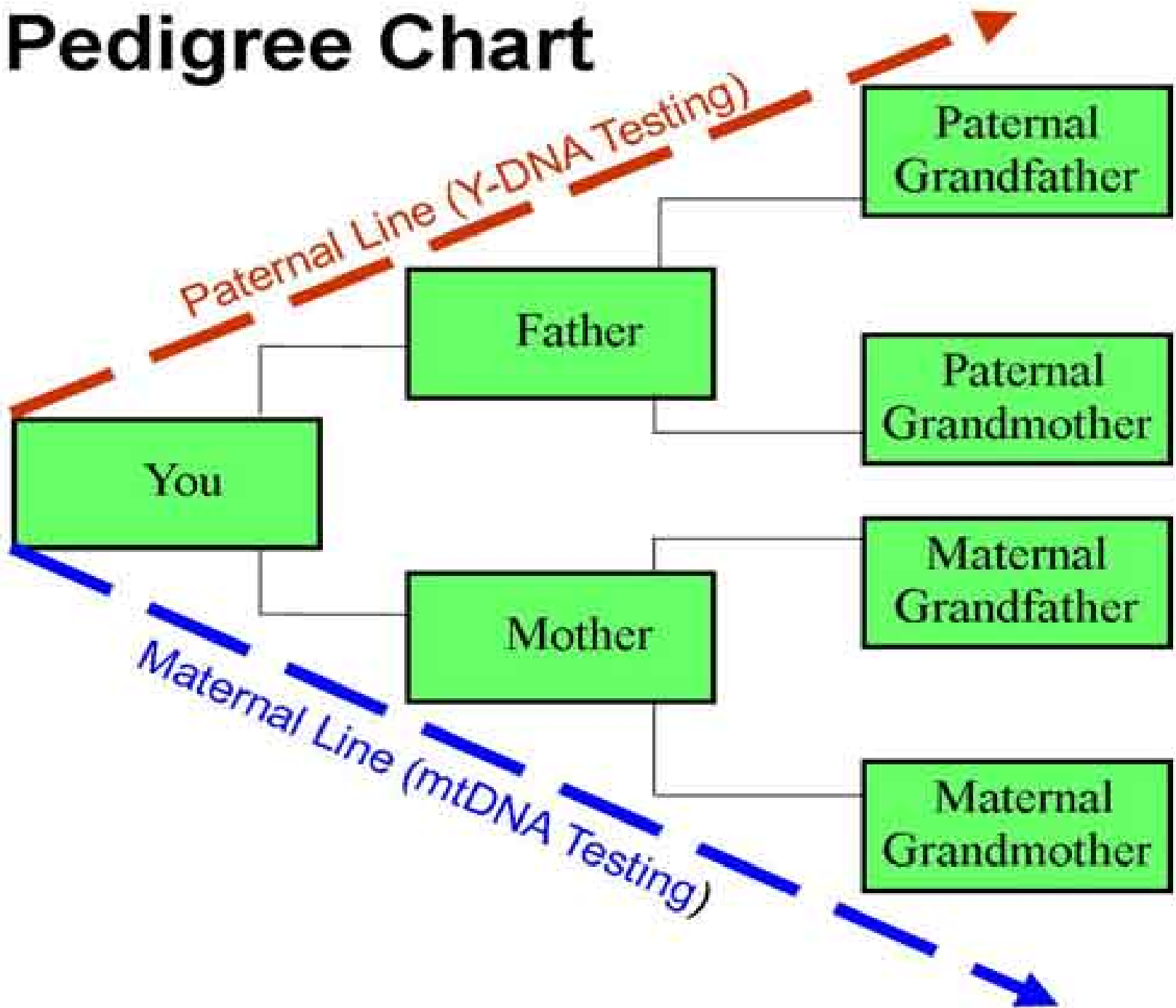

Autosomal DNA (*atDNA*)

Our Autosomal DNA is (theoretically) representative of our whole ancestry.

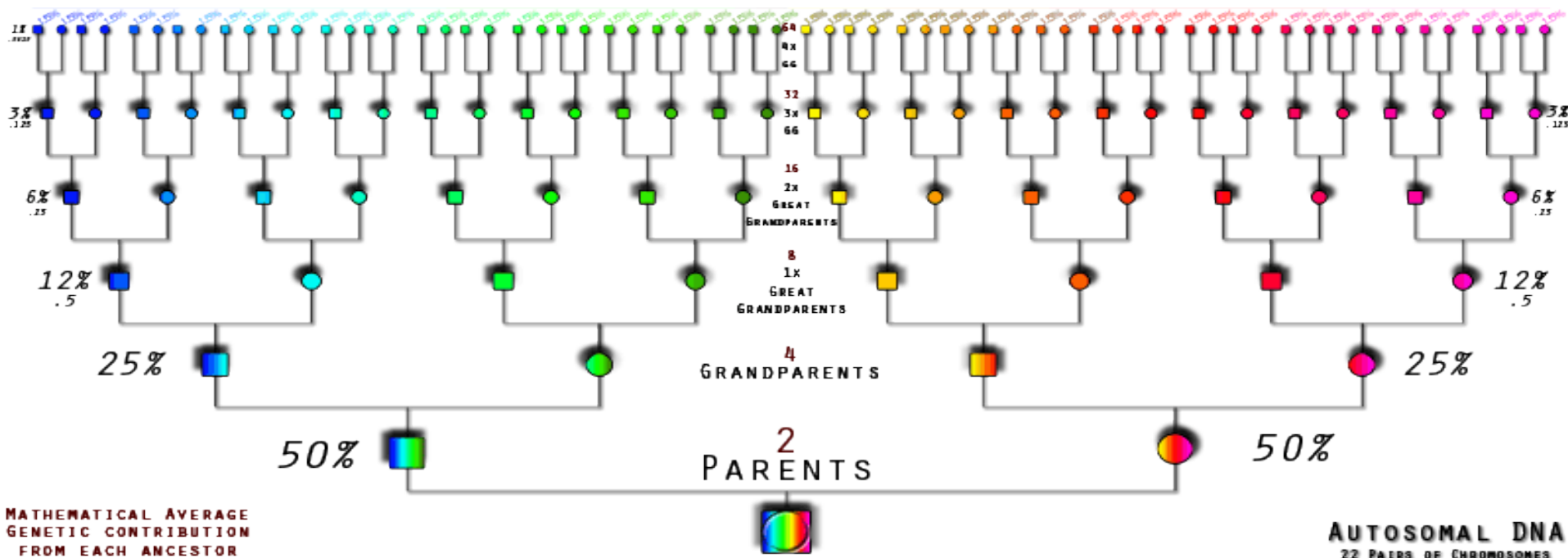

YOUR PART



23andMe

Welcome to you

BYS (before you spit)





***Not as
easy
as it
looks.***



**EXEMPT
HUMAN
SPECIMEN**

THEN:



**WHAT YOU
FIND OUT**

Kind of weird to think about.

Sent: Thursday, August 28, 2014 4:02 AM

To: Pennavaria, Katherine



Your sample has reached the lab.

We've received the saliva sample registered to:

Katherine Pennavaria - 19401401035494

Our technicians are inspecting your sample and preparing it for analysis. You'll receive an email when your results are ready in approximately 3-4 weeks.



Yourself in numbers



CONNECTIONS

DNA RELATIVES

- List View
- Map View
- Surname View

Show: both sides ▾
Sort: relationship ▾
25 per page ▾
1 - 25 of 932

	Katherine Pennavaria Female	You	United States Chicago, IL Pennavaria Nasca LaCerra 13 more HV4a	UPDATE YOUR PROFILE
	Adam Pennavaria Male	Son 50.0% shared, 26 segments	HV4a R1b1b2a1a	Owned Profile
	eric braun Male, b. 1969	2nd Cousin 5.11% shared, 13 segments	V E1b1a8a	Sharing Genomes Send a Message
	Marsha McVey Female	2nd to 4th Cousin 1.48% shared, 4 segments	United States Mt. Pleasant, MI Wooster, OH Lewisville, OH 3 more Northern Europe McVey Ruble Bartenslag Stallsmith V	Public Match Send a Message
	Peggy LaCerra Female, b. 1954	3rd to 4th Cousin 0.69% shared, 3 segments	United States Northern Europe H1a	Public Match Send a Message
	Female	3rd to 4th Cousin 0.54% shared, 3 segments	U5b2b	Send an Introduction
	Patti Davis	3rd to 5th Cousin	United States Pasco, WA, Spokane WA Wukusich	Public Match

FIRST THROUGH THIRD COUSINS

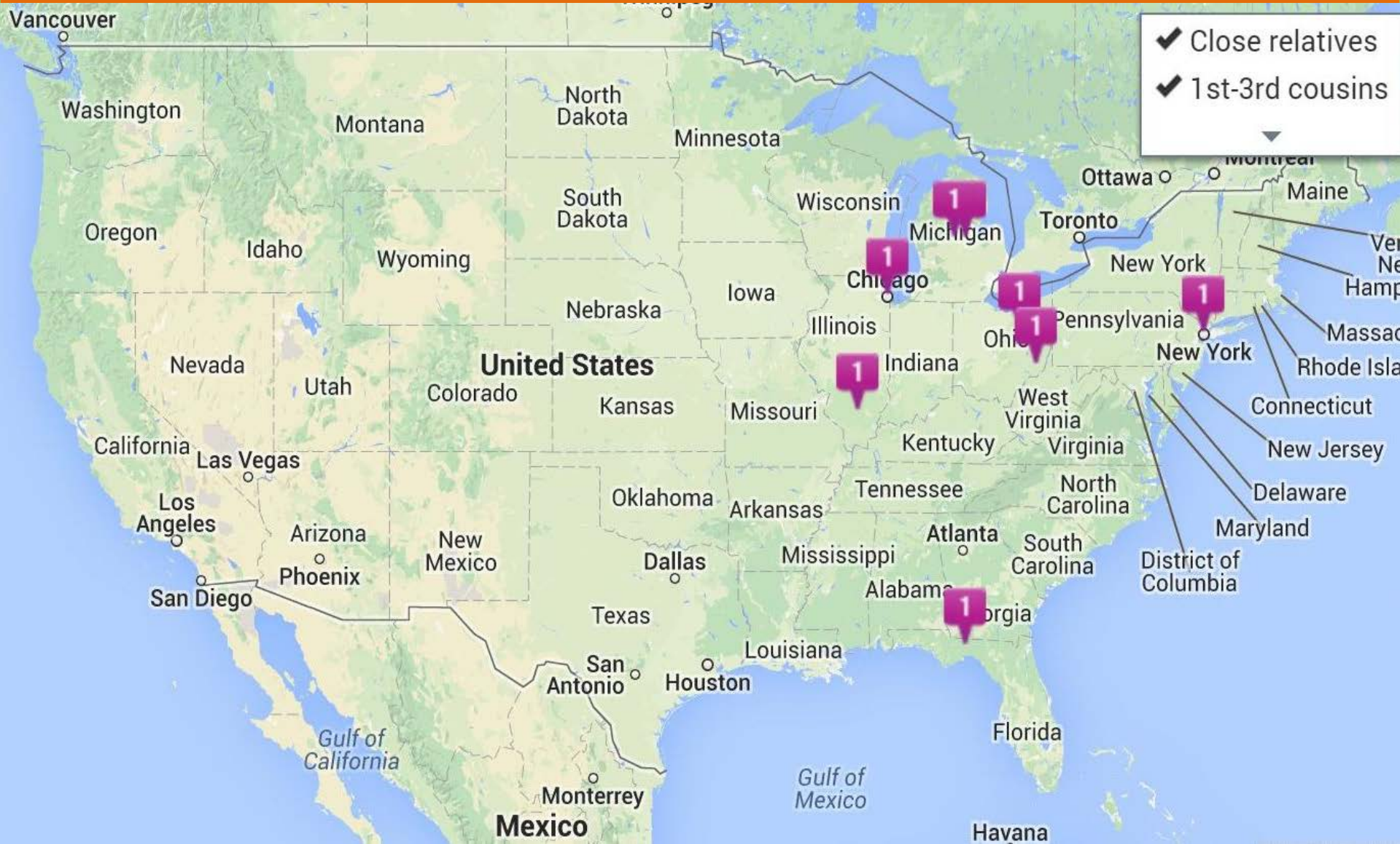

FOURTH THROUGH SIXTH COUSINS



HAPLOGROUPS

HV4a is a subgroup of R0

Locations of haplogroup R0 circa 500 years ago, before the era of intercontinental travel.

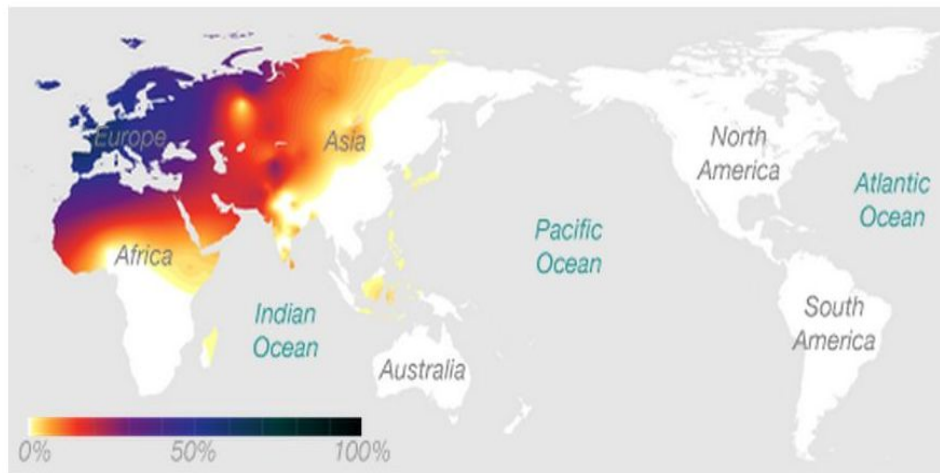

R0 originated more than 35,000 years ago in the Near East, at a time when humans were moving outward from the region into other parts of Asia and Europe. The haplogroup spawned several daughter branches that were central in those migrations, notably haplogroups H and V, both of which are most commonly found in Europe.

Maternal haplogroups are families of mitochondrial DNA types that all trace back to a single mutation at a specific place and time. By looking at the geographic distribution of mtDNA types, we learn how our ancient female ancestors migrated throughout the world.

Haplogroup: R0, a subgroup of R

Age: 35,000 years

Region: Near East, northern Africa, Western Eurasia

Example Populations: Saudi Arabs, Yemeni Jews, Bedouin

Highlight: R0 includes HV and its subgroups, H, V, and a scattering of rare lineages across the Near East and Europe.

Haplogroups of You and Your Connections

HV4a

Katherine Pennavaria

Haplogroups of Example Profiles

Who knew?

This lab estimates your genome-wide percentage of Neanderthal ancestry

Got Neanderthal DNA?

An estimated 2.4% of your DNA is from Neanderthals.

Katherine Pennavaria (you)



14th percentile

Average 23andMe user



For better comparison with your ethnic group, please [complete your profile](#).

MODERN HUMANS

Higher brow
Narrower shoulders
Slightly taller



NEANDERTHALS

Heavy eyebrow ridge
Long, low, bigger skull
Prominent nose with developed



In case you need to share that.

Neanderthal Shirts Gifts

Display:



Show:

60



Sort:

Popular



38 results



2.8% Neanderthal Shirt

\$25.95



3.1% Neanderthal Shirt

\$25.95



3% Neanderthal Shirt

\$25.95

SURVEYS

Click on a survey to get started or to view your results



Where Are You From?

START SURVEY



Female Fertility

About this survey | Published: November 2011

START SURVEY



Urinary Incontinence and Pelvic Floor Disorders

About this survey | Published: November 2011

START SURVEY



Skin Aging

About this survey | Published: September 2010

START SURVEY



Antidepressant Efficacy and Side Effects

START SURVEY

RESEARCH QUESTIONS

Have you ever sprained your ankle?

Which best describes your employment status?

Compared to your friends, how much do you like sweets or other sugary food?

Do you cry easily?

Have you ever had allergic rhinitis (stuffed or dripping nose caused by allergies)?

Have you ever been diagnosed with mania (been told by a medical professional that you were having a manic episode)?

Do you have an os trigonum (extra bone behind your ankle bone)?

What best describes your ancestry/ethnicity? Please check all that apply.

How many times have you been told by a doctor that you had strep throat?

Have any of your grandparents, parents, brothers, sisters, aunts, or uncles ever been

HOW TO DECIDE

ISOGG.ORG

← → ↻ www.isogg.org



INTERNATIONAL SOCIETY OF GENETIC GENEALOGY

The first society founded to promote the use of DNA testing in genealogy

[JOIN ISOGG](#) | [OUR MISSION](#) | [ABOUT ISOGG](#) | [Yahoo! FORUM](#) | [ISOGG PRESS](#) | [CONTACT](#)

ISOGG and [Southern California Genealogical Society](#) co-sponsor

"Family History and DNA: Genetic Genealogy in 2014

Thursday, June 5, 2014 at the Los Angeles Marriott Burbank Hotel

To keep up with the latest news on both Jamboree and DNA Day see the [Jamboree blog](#).

2014 International Genetic Genealogy Conference

Organized by the Institute for Genetic Genealogy

August 15-17, 2014 in Washington, DC at the National 4-H Youth Conference Center

See www.i4gg.org for details.

HOME

RESOURCES

FOR NEWBIES

FOR ADMINS

FAMOUS DNA

Y SNP TREE

SUCCESS STORIES

SPEAKERS LIST

MEETINGS/EVENTS

Welcome to ISOGG!

Our mission also includes educating others about the use of genetics in genealogy. This can be accomplished through workshops, this website, speaker's bureau, forums, and meetings.

Meetings are important, as they allow for the dissemination of information and to maintain the momentum. While we are geographically spread out, we will do what is possible to hold meetings.

WHAT'S NEW?

[ISOGG Sitemap](#)

[DNA Consultants/Services](#)

[Newsletter](#)

[Wiki](#)

HEALTH DATA NO LONGER AVAILABLE

Status of our health-related genetic reports.

We no longer offer our health-related genetic reports to new customers to comply with the U.S. Food and Drug Administration's directive to discontinue new consumer access during our regulatory review process

At this time, we do not know the timeline as to which health reports might be available in the future or when they might be available.

QUESTIONS TO ASK

What is the size of their DNA database?

Does the company allow downloading of results?

How much does it cost?

Which results are you most interested in?

THANK YOU!

Thank you!

Katherine Pennavaria

k.pennavaria@wku.edu

Rosemary Meszaros

rosemary.meszaros@wku.edu

To get the PDF:

- In the Download box, click the presentation name
- Click “Download File”
- In the pop-up window:
 - “Click to download”
 - Save to your computer

KDLA.Certification@ky.gov

[Services to Libraries](#)

